



MA.105.C

### Specification

<b>Part No.</b>	<b>MA105.C.LB.001</b>
<b>Product Name</b>	MA105 GPS/GLONASS and Cellular 2in1 Combination Hercules Screw-mount (Permanent mount)
<b>Features</b>	<p>Low profile - Height 29 mm and Diameter 49mm Heavy duty screw mount UV and vandal resistant PC housing</p> <p>Cellular -Penta Band Antenna 850/900/1800/1900/2100 GSM/GPRS/CDMA/EVDO/UMTS/HSPA/WCDMA Cellular - 3 Metres Low Loss CFD200 SMA(M)</p> <p>GPS -1575.42MHz - Two Stage 27dB+ LNA GLONASS - 1602MHz - Two Stage 27dB+ LNA GPS/GLONASS - 3 Metres RG174 SMA(M)</p> <p>IP67 &amp; IP69K compliance Cables and connectors are fully customizable ROHS Compliant</p>



## 1. Introduction

The MA.105.C GPS/GLONASS and Cellular Combination Hercules Antenna is the newest upgraded model of Taoglas popular Hercules series. It is a combination 2in1 high performance GPS/GLO-NASS and penta-band cellular antenna solution for the most reliable asset tracking and remote monitoring. The GPS/GLONASS antenna inside has been optimized to work on both GPS and GLO-NASS bands allowing the antenna to see the maximum amount of satellites in the sky and improving tracking accuracy enormously especially in built up areas, the urban canyons where traditional GPS only solutions struggle to maintain a lock driving around corners.

The penta-band cellular antenna delivers high efficiency at all common 2G/3G bands worldwide, ideal for use on GSM, GPRS, CDMA systems.

Durable UV and robust PC housing is resistant to vandalism and direct attack. At only 29 mm height it complies with the latest EU height restrictions directives for roof-mounted objects, with a diameter of 49 mm. It is designed to be covert, and not catch on tree-branches.

The Hercules can be mounted on metal or non-metal structures as it has a metal ground-plane base integrated inside. A waterproof closed cell foam seal under the base adheres to the surface it is mounted on and can stretch to fit curved surfaces typical on vehicles, preventing water entering through any mounting hole.

## 2. Specification

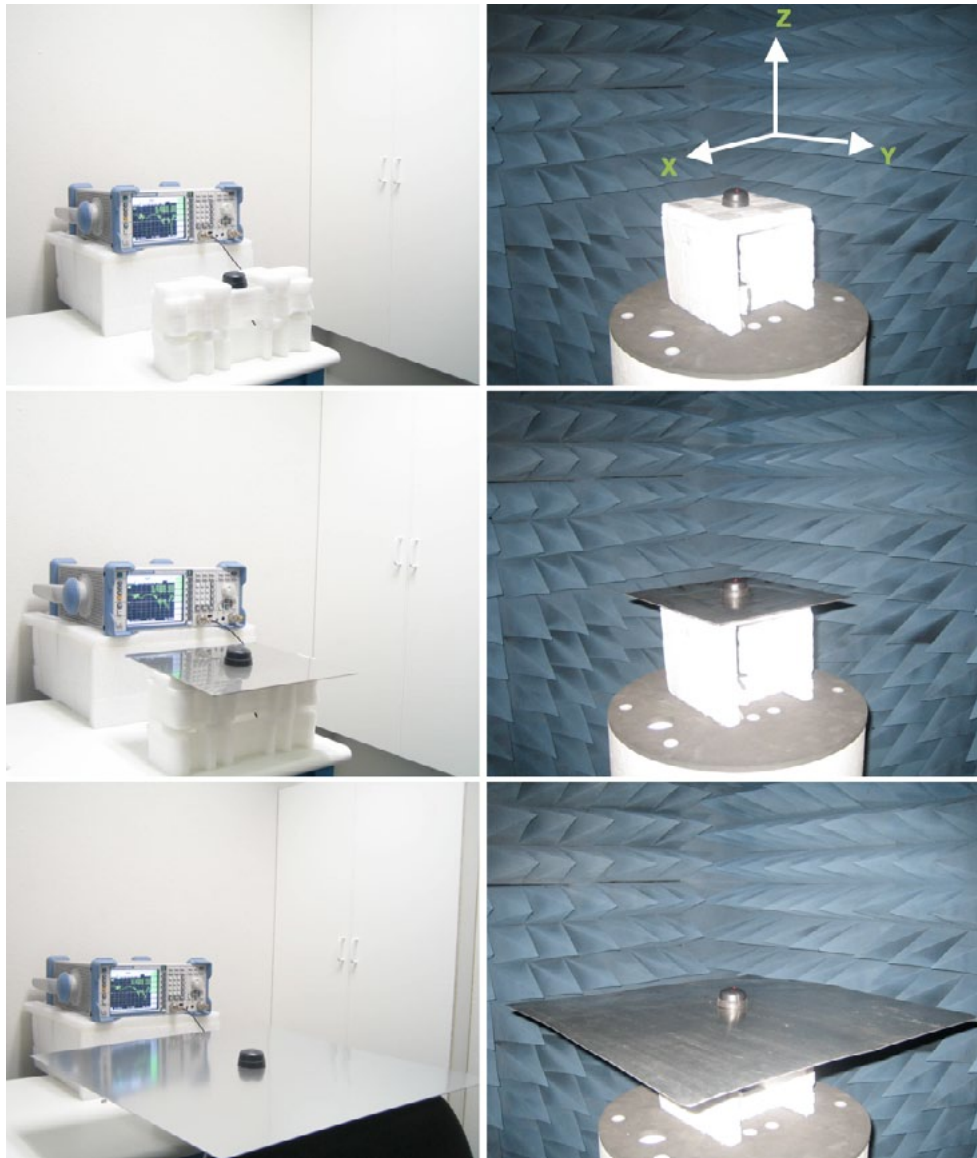
ELECTRICAL						
Standard	AMPS	GSM	DCS	PCS	3G	
Band (MHz)	850	900	1800	1900	2100	
Frequency (MHz)	824 ~ 896	880 ~ 960	1710 ~ 1880	1850 ~ 1990	1920 ~ 2170	
<b>Return Loss (dB)</b>						
<b>Cable Length</b>	0.3m	-6.5	-6.0	-8	-7	-5
	1.0m	-9.5	-8	-16	-17	-15
	2.0m	-10	-9	-21	-20	-18
	3.0m	-13	-11	-21	-21	-19
	5.0m	-14	-14	-25	-25	-23
<b>Efficiency (%)</b>						
<b>Cable Length</b>	0.3m	38	MEDICAL	54	58	50
	1.0m	31	35	42	36	31
	2.0m	23	20	32	23	21
	3.0m	25	29	22	23	18
	5.0m	11	11.5	11	12	11
<b>Peak Gain (dB)</b>						
<b>Cable Length</b>	0.3m	2.0	3.3	3.6	4.0	3.0
	1.0m	1.2	1.3	1.8	2	1.2
	2.0m	0.5	-0.35	1.5	0	-0.1
	3.0m	0.1	1.6	0.1	0.6	-0.9
	5.0m	-2.5	-2.4	-3.0	-2.3	-2.0
<b>Polarization</b>			Linear			
<b>Impedance (Ohms)</b>			50 Ohms			
<b>Input Power</b>			10 Watts max.			
<b>VSWR</b>			<3.5:1			

## 2. Specifications

ELECTRICAL GPS & GLONASS	
Frequency	1574~1606MHz
Impedance	50 ohm
VSWR	2.0 Max
GPS Patch Gain @ Zenith	-1.4dB Passive Gain @ Zenith
GLONASS Patch Gain @ Zenith	-1.3dBi Gain @ Zenith
Out Band Rejection	fo = 1575.42MHz fo ± 30 MHz 5dB Min. fo ± 50 MHz 20dB Min. fo ± 100 MHz 25dB Min.
Input Voltage	Typ. 2.5~5.5V
Total Gain @ Zenith	27dB typical at 3.0V
Current Consumption	10mA typical at 3.0V
Noise Figure	1.3dB typical
MECHANICAL	
Dimensions	Height 28.5mm x Diameter 49.2mm
Casing	UV resistant PC
Base and thread	Nickel plated steel
Thread diameter	18mm
Weather proof gasket	CR4305 foam with 3M9448WC double-side adhesive
Cable pull	8 Kgf
Recommended Mounting Torque	24.5Nm
Maximum Mounting Torque	29.4Nm
ENVIRONMENTAL	
Waterproof	IP-67 & IP-69K
Corrosion	5% NaCl for 96hrs - Nickel plated steel base and thread
Temperature Range	-40°C to +85°C
Thermal Shock	100 cycles -40°C to +80°C
Humidity	Non-condensing 65°C 95% RH
Shock (Drop Test)	1m drop on concrete 6 axes

**\*Note:** The return loss, efficiency and gain measurements in the above table, were taken for the antenna mounted on a 30x30 cm metal plate. For a specific case performance refers to the below plots.

### 3. Test Set Up



**Figure 1.** MA105 Antenna test set up in free space, 30x30 cm metal plate and 60x60 cm metal plate, R&SZVL6 VNA (Left) and R&S4100 CTIA 3D Chamber (Right).

## 4. Cellular Antenna Parameters

### 4.1 Return Loss

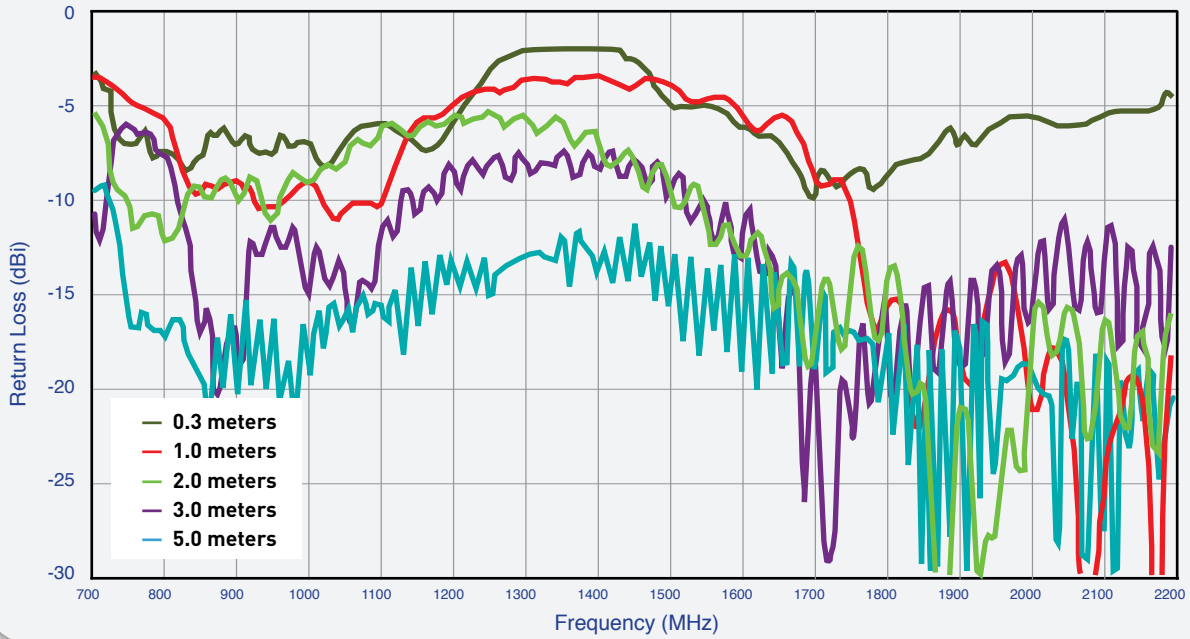


Figure 2. Return Loss of the MA105 antenna in free space

### 4.1 Return Loss

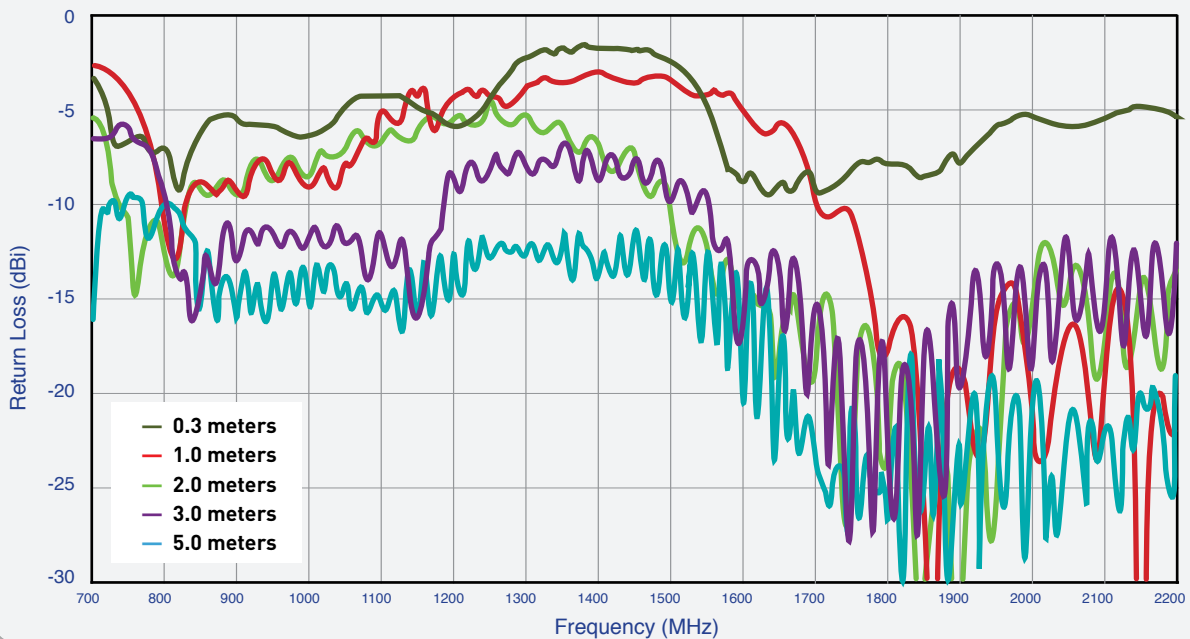


Figure 3. Return Loss of the MA105 antenna on 30\*30cm metal plate

### 4.1 Return Loss

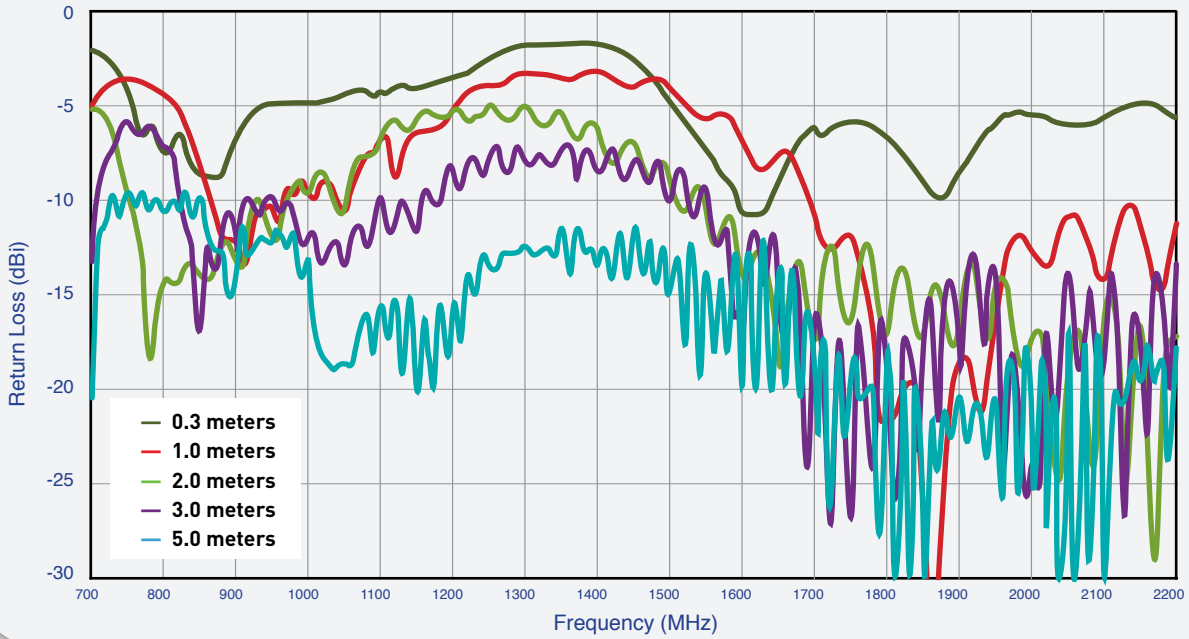


Figure 4. Return Loss of the MA105 antenna on 60\*60cm metal plate.

### 4.2 Efficiency

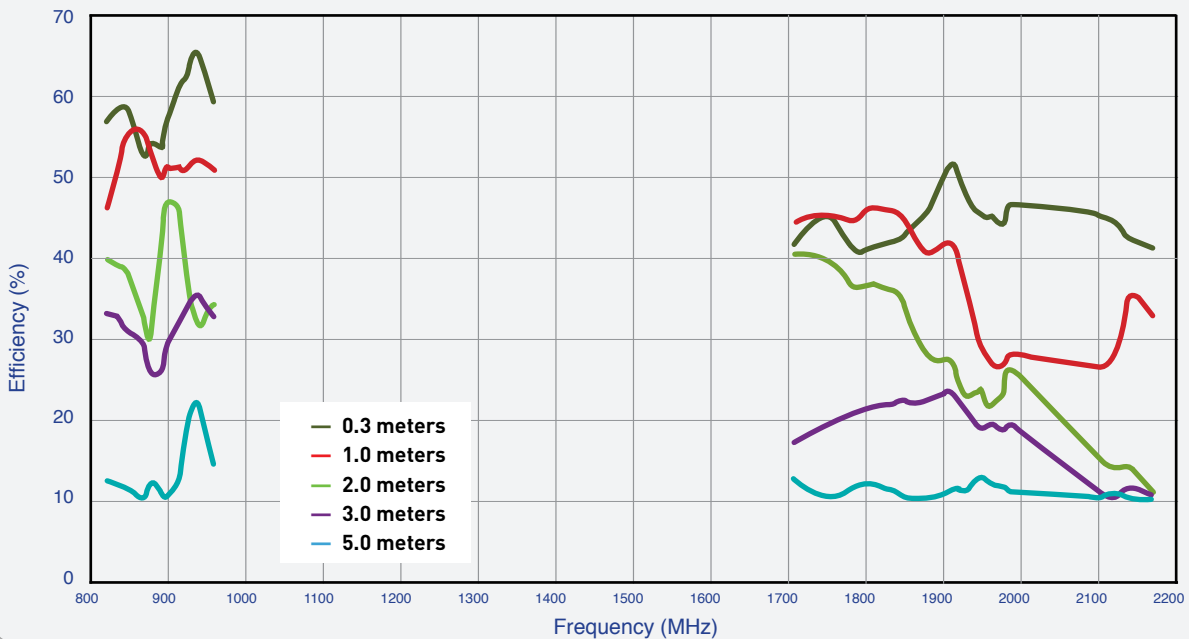


Figure 5. Efficiency of the MA105 antenna in free space.

## 4.2 Efficiency

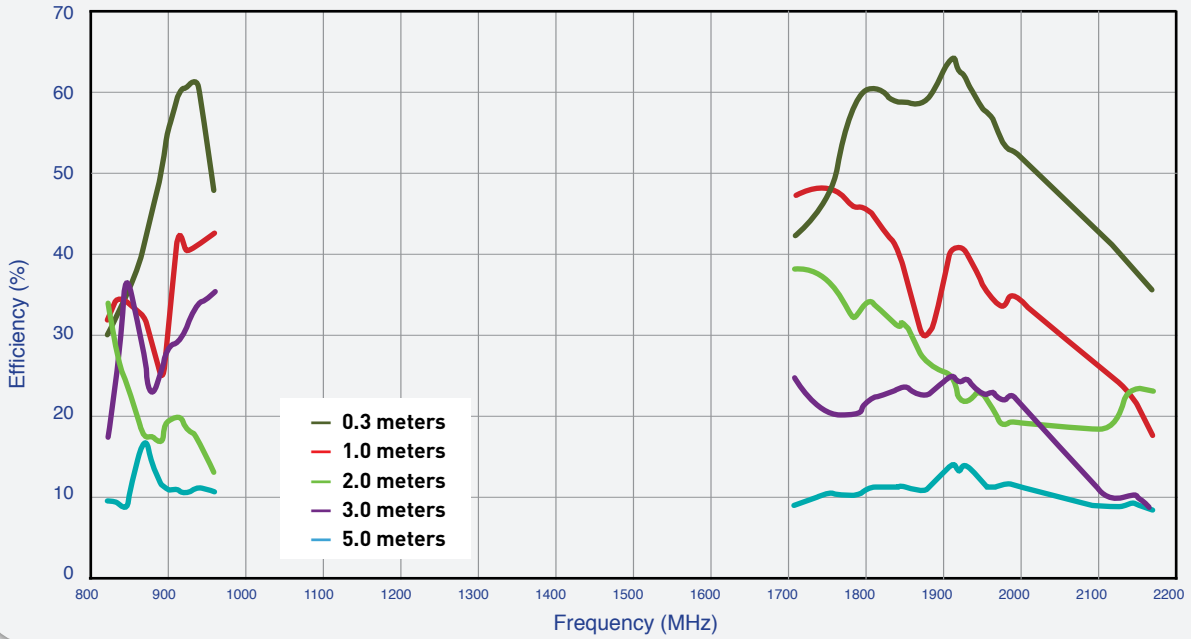


Figure 6. Efficiency of the MA105 antenna on 30\*30cm metal plate.

## 4.2 Efficiency

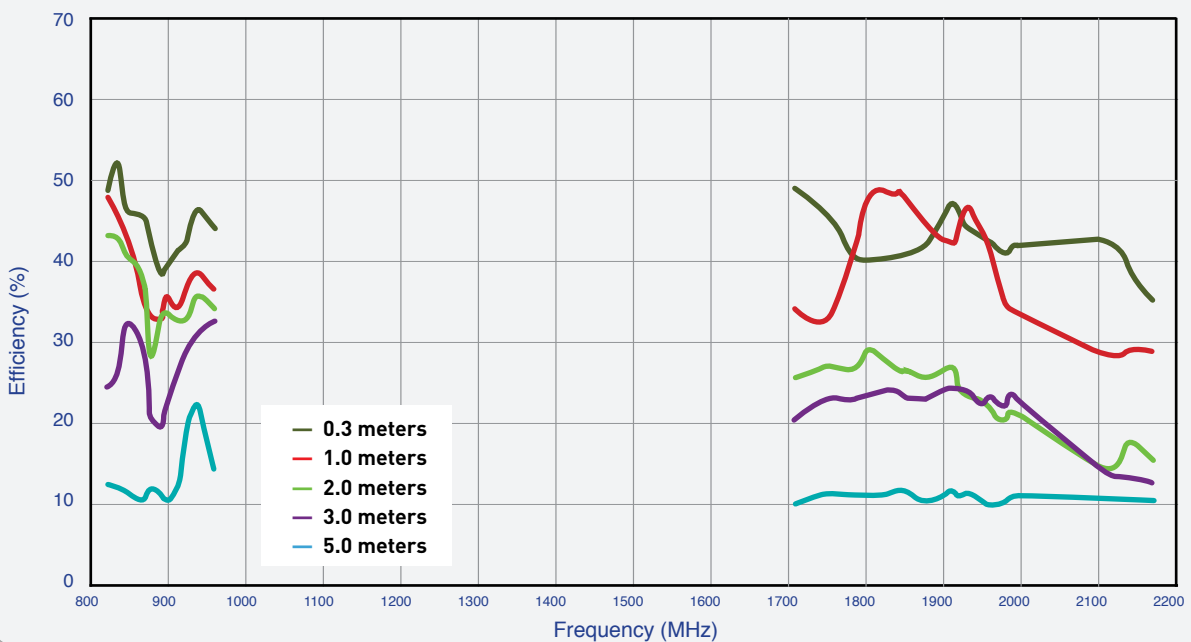


Figure 7. Efficiency of the MA105 antenna on 60\*60cm metal plate.



### 4.3 Peak Gain

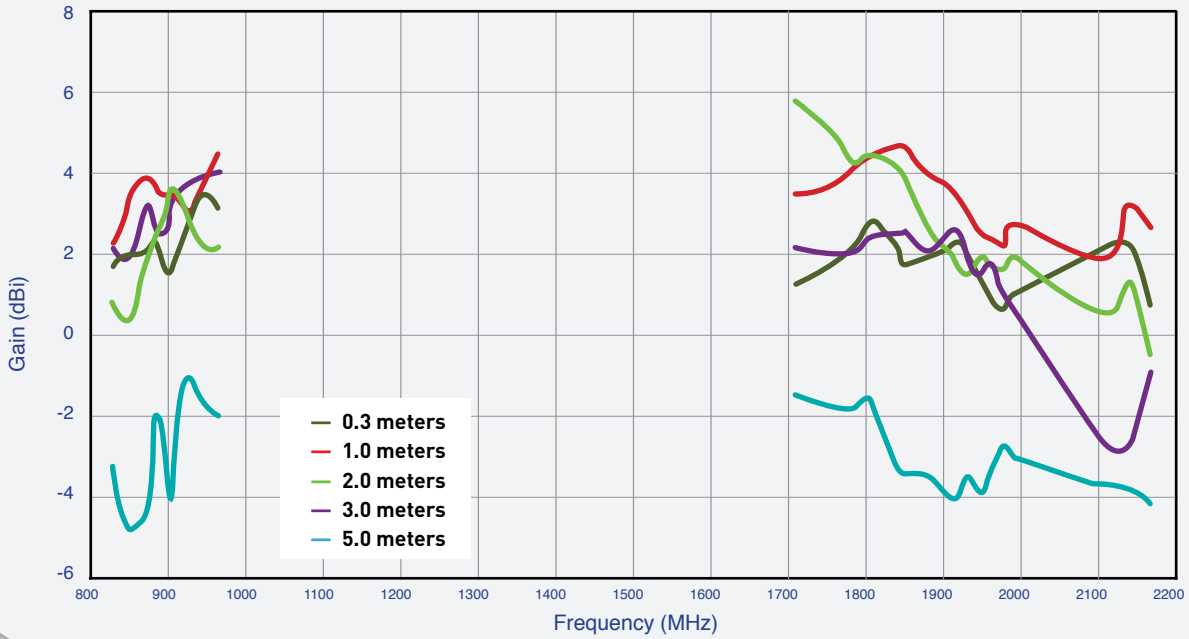


Figure 8. Gain of the MA105 antenna in free space

### 4.3 Peak Gain

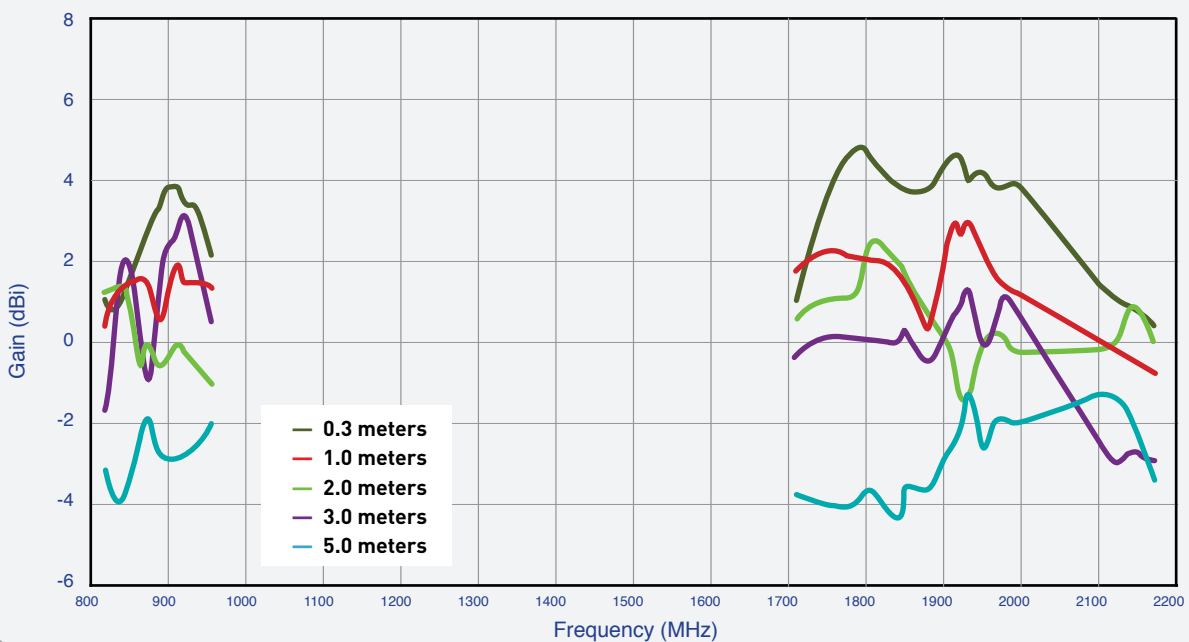


Figure 9. Gain of the MA105 antenna on 30\*30cm metal plate

### 4.3 Peak Gain

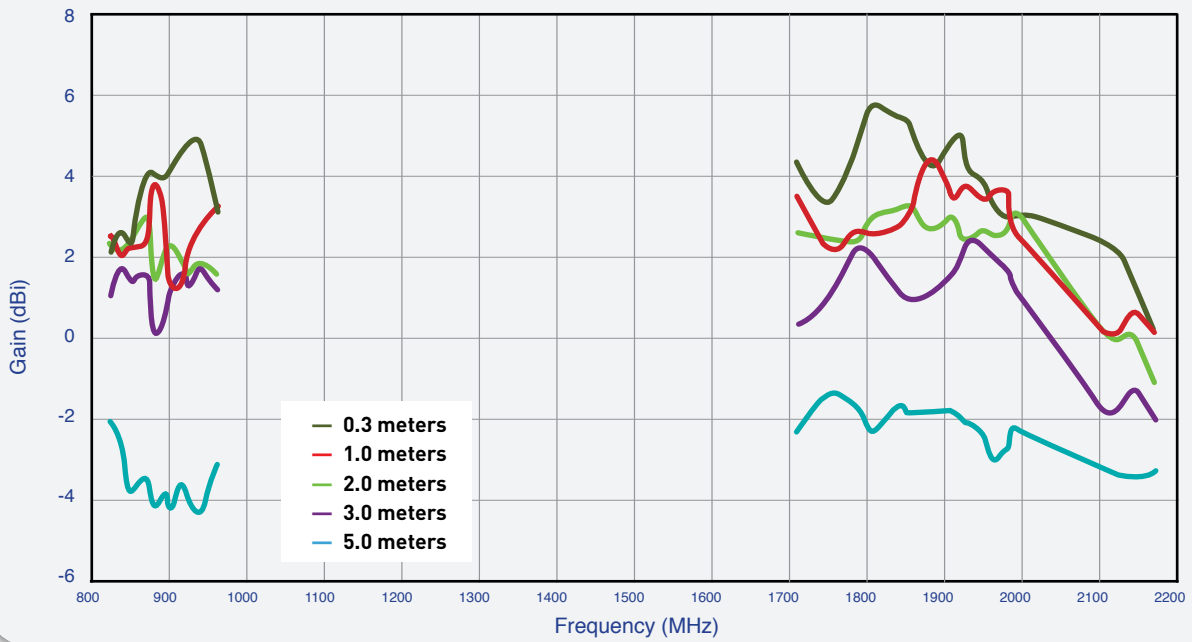
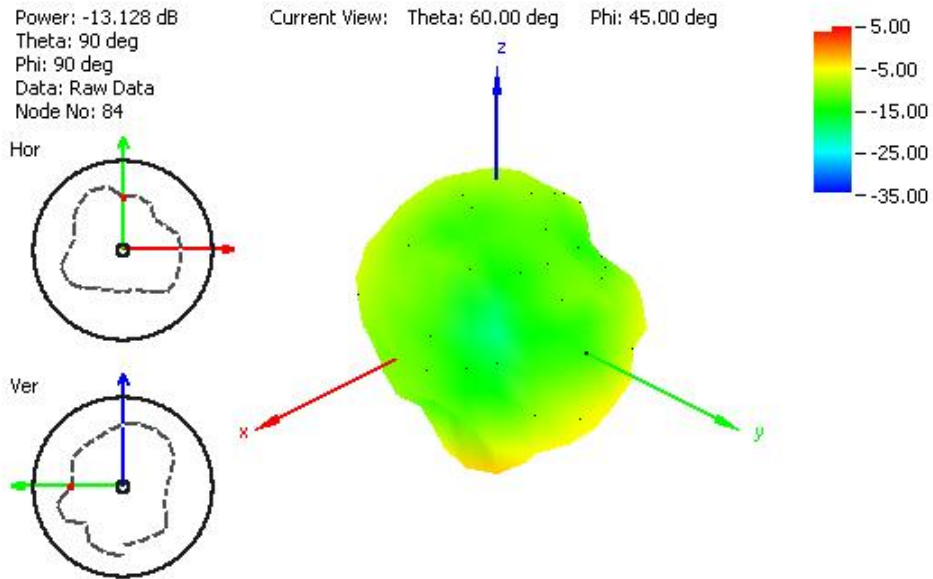
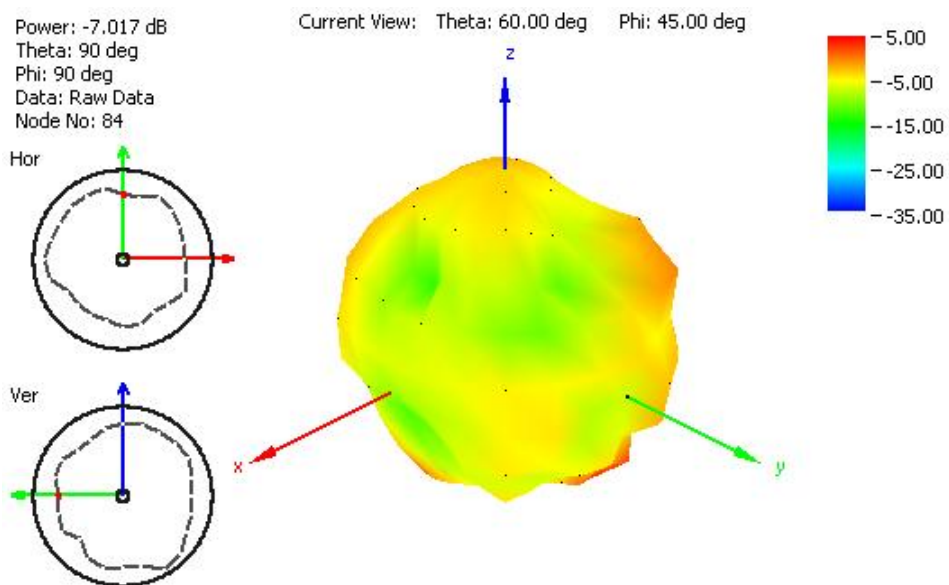


Figure 10. Gain of the MA105 antenna on 60\*60cm metal plate

## 4.4 Radiation pattern

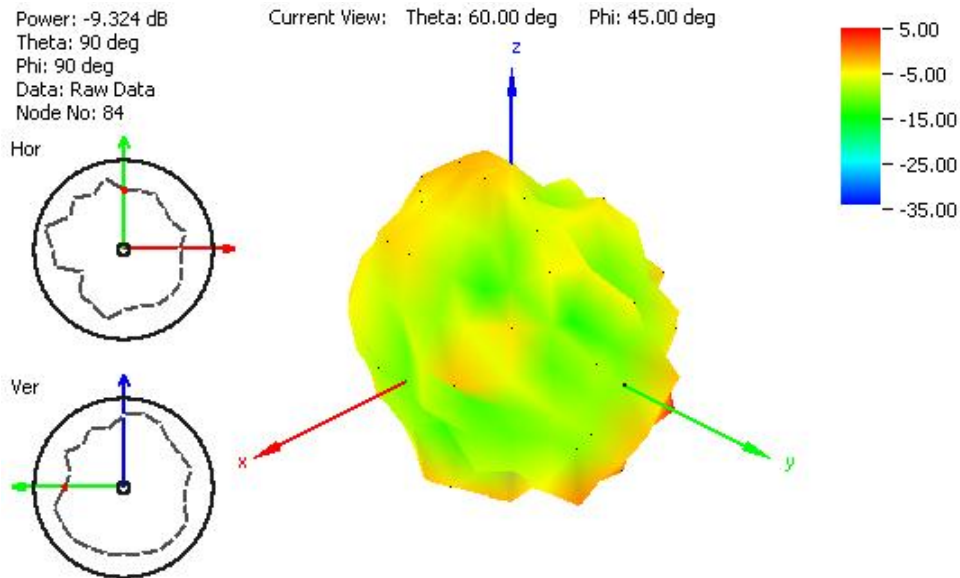


**Figure 11.** Radiation pattern at 849 MHz, Figure 1 as reference (dB), with 2 meter RG174 cable and free space

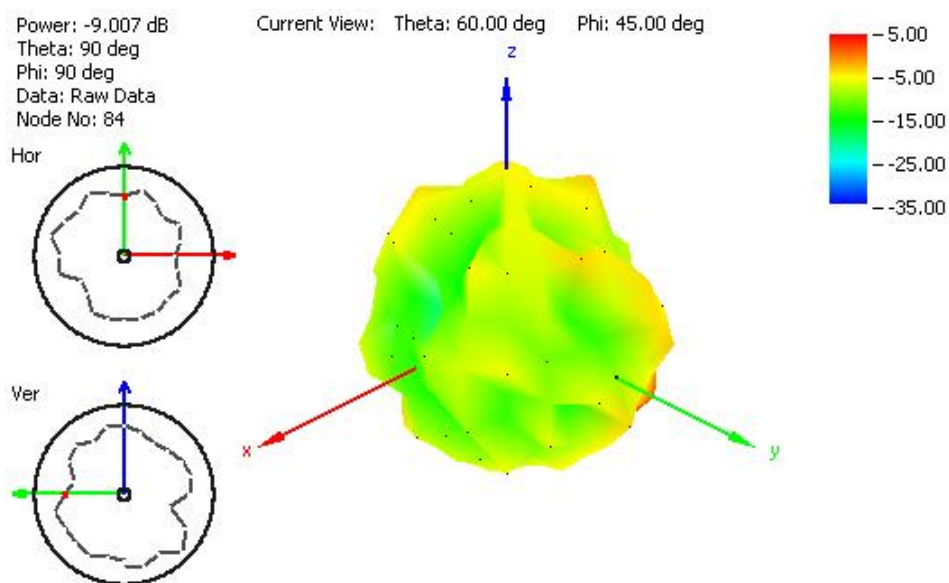


**Figure 12.** Radiation pattern at 915 MHz, Figure 1 as reference (dB), with 2 meter RG174 cable and free space

## 4.4 Radiation pattern

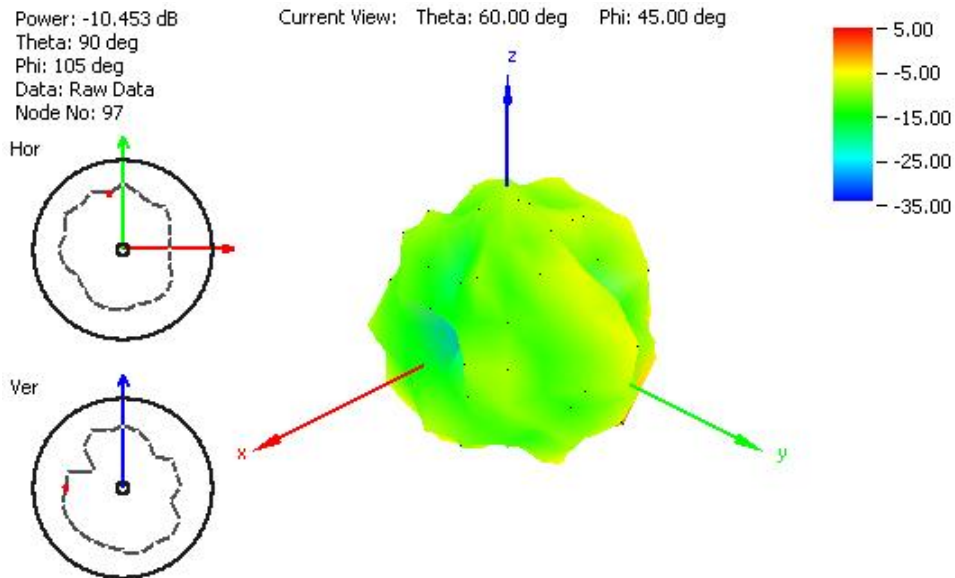


**Figure 13.** Radiation pattern at 1805 MHz, Figure 1 as reference (dB), with 2 meter RG174 cable and free space

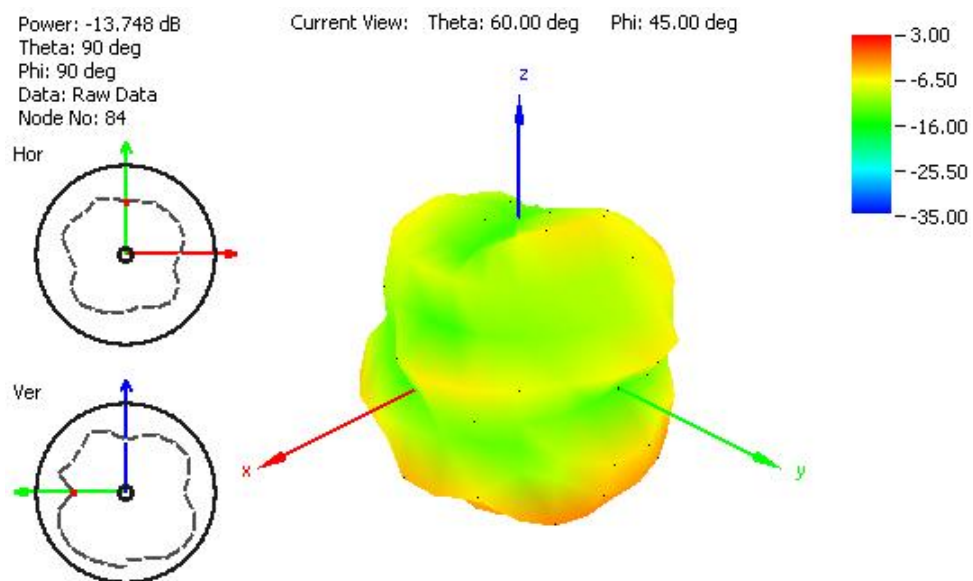


**Figure 14.** Radiation pattern at 1910 MHz, Figure 1 as reference (dB), with 2 meter RG174 cable and free space

## 4.4 Radiation pattern

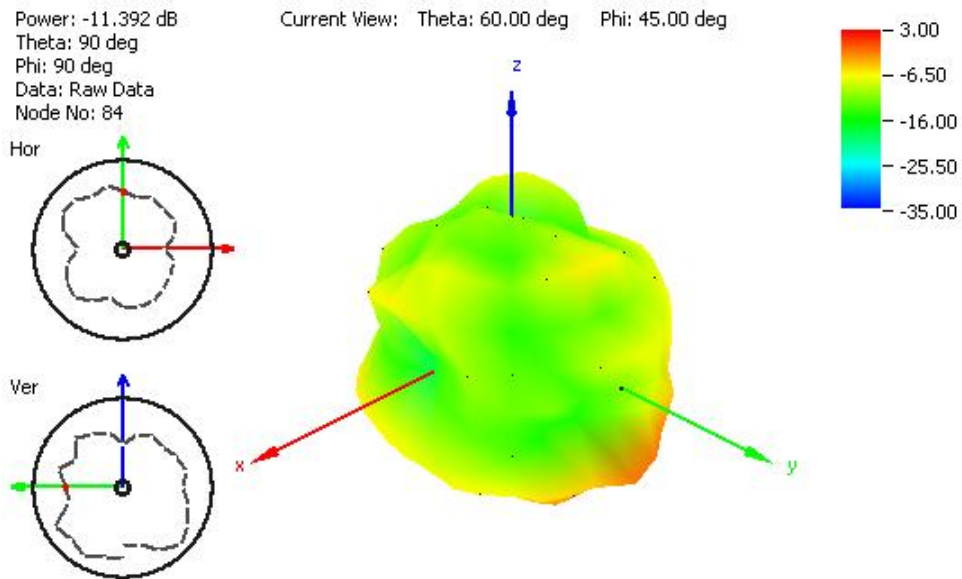


**Figure 15.** Radiation pattern at 2110 MHz, Figure 1 as reference (dB), with 2 meter RG174 cable and free space.

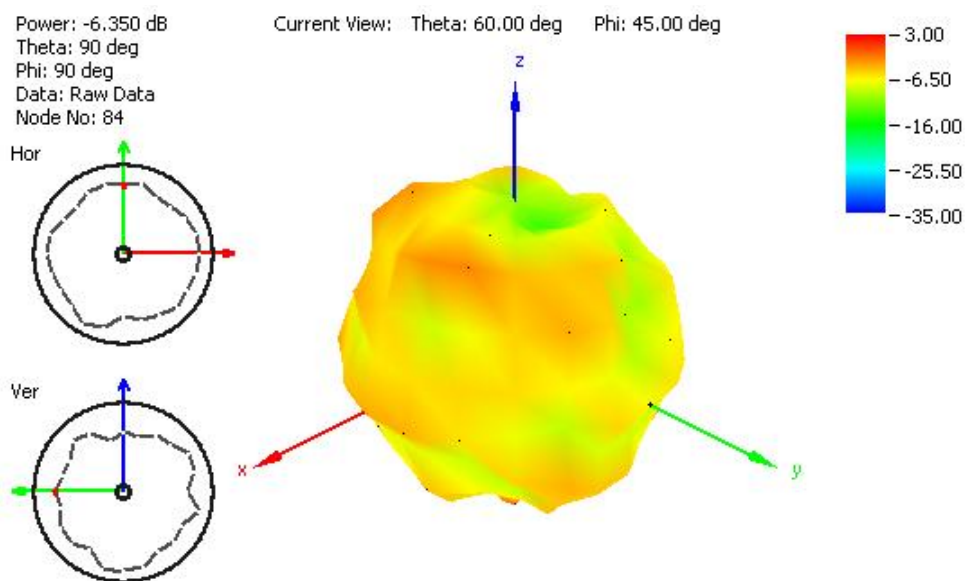


**Figure 16.** Radiation pattern at 849 MHz, Figure 1 as reference (dB), with 2 meter RG174 cable and 30x30 cm metal plate

## 4.4 Radiation pattern

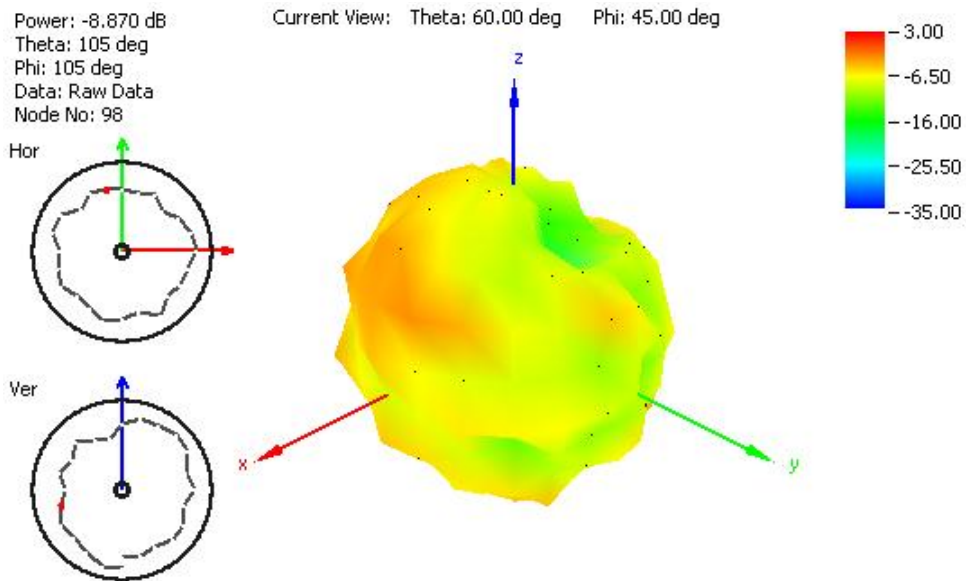


**Figure 17.** Radiation pattern at 915 MHz, Figure 1 as reference (dB), with 2 meter RG174 cable and 30x30 cm metal plate

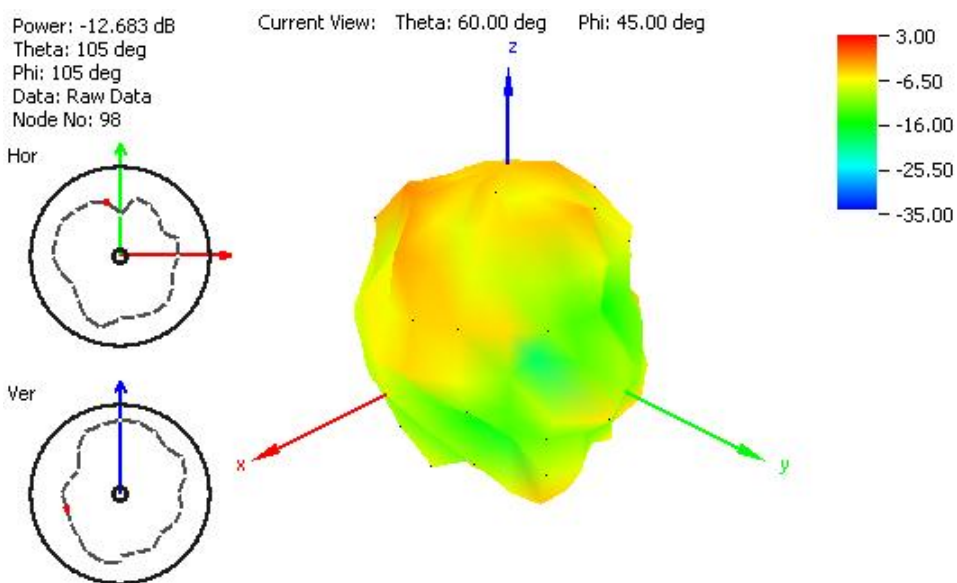


**Figure 18.** Radiation pattern at 1805 MHz, Figure 1 as reference (dB), with 2 m RG174 cable and 30x30 cm metal plate

## 4.4 Radiation pattern

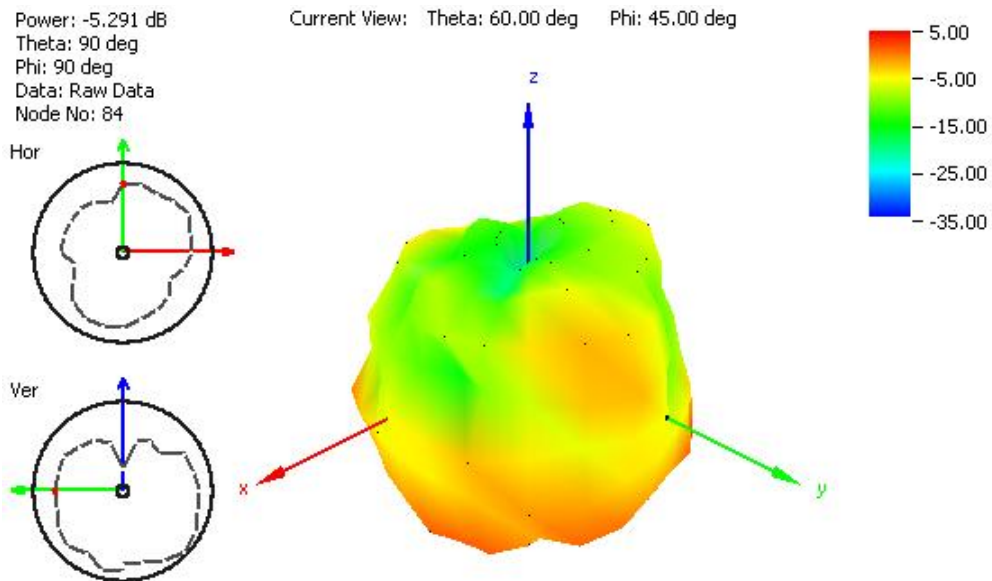


**Figure 19.** Radiation pattern at 1910 MHz, Figure 1 as reference (dB), with 2 meter RG174 cable and 30x30 cm metal plate

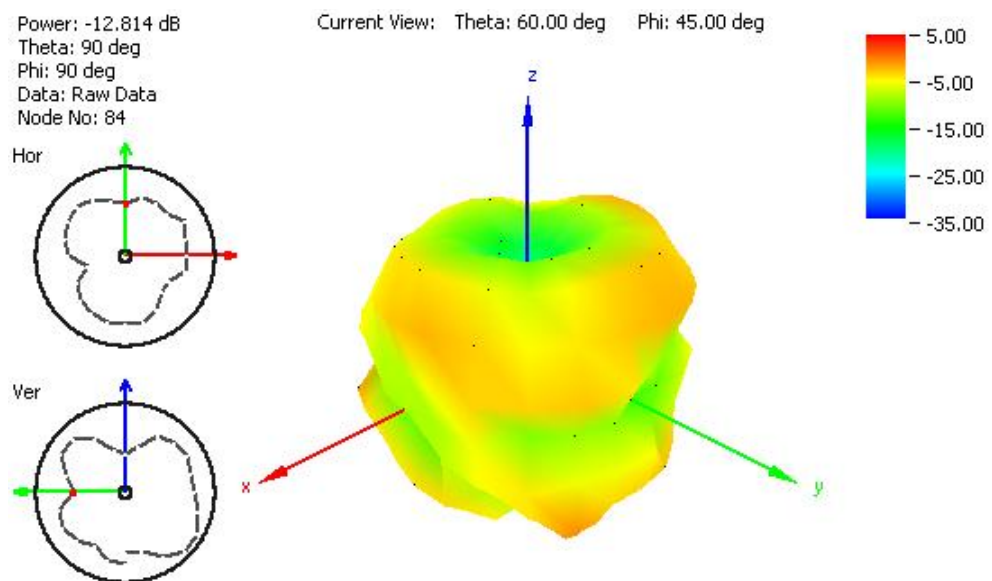


**Figure 20.** Radiation pattern at 2110 MHz, Figure 1 as reference (dB), with 2 meter RG174 cable and 30x30 cm metal plate

## 4.4 Radiation pattern



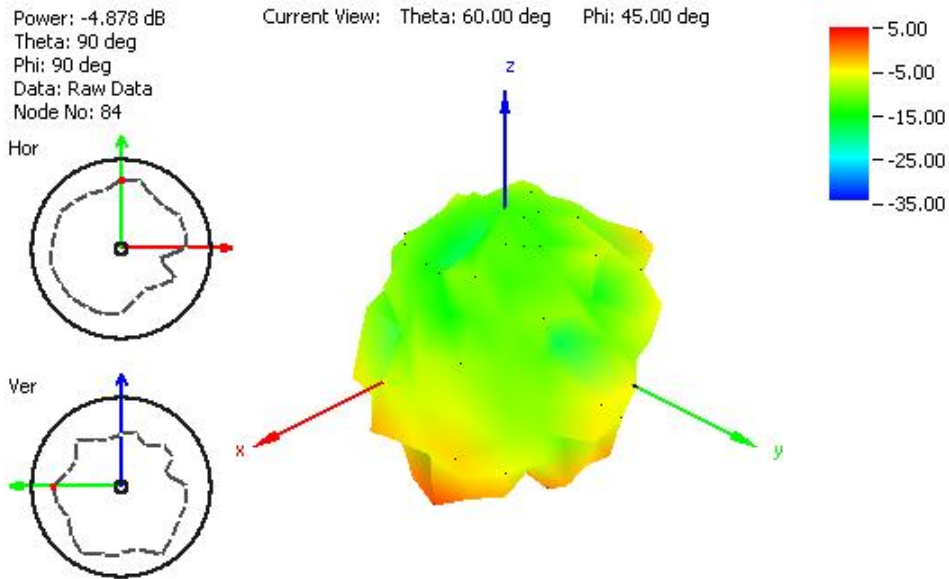
**Figure 21.** Radiation pattern at 849 MHz, Figure 1 as reference (dB), with 2 meter RG174 cable and 60x60 cm metal plate



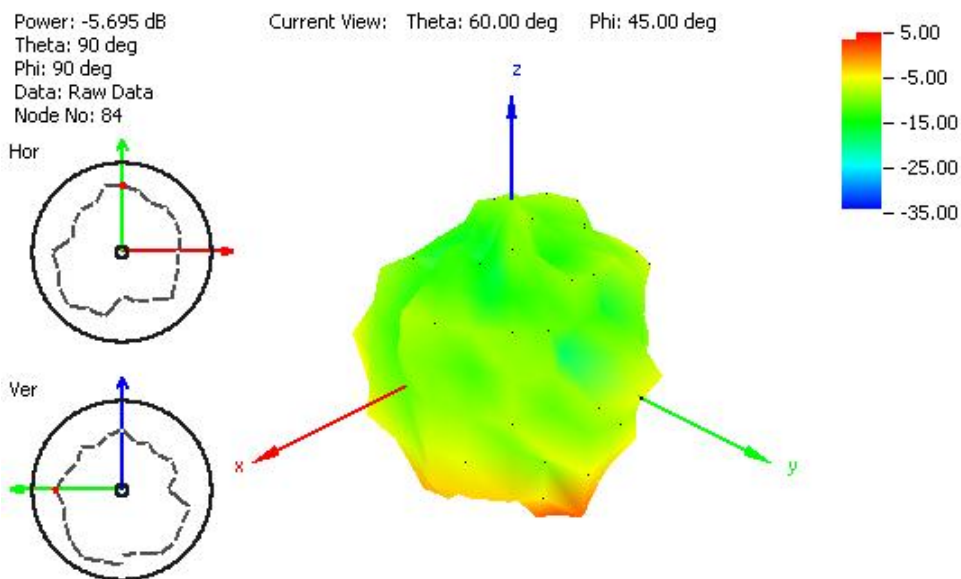
**Figure 22.** Radiation pattern at 915 MHz, Figure 1 as reference (dB), with 2 meter RG174 cable and 60x60 cm metal plate



## 4.4 Radiation pattern

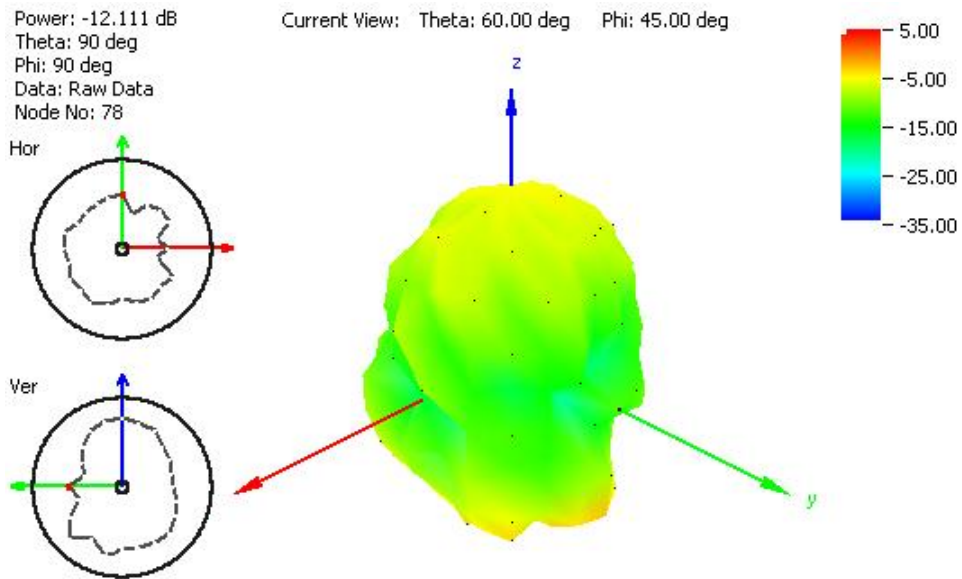


**Figure 23.** Radiation pattern at 1805 MHz, Figure 1 as reference (dB), with 2 meter RG174 cable and 60x60 cm metal plate



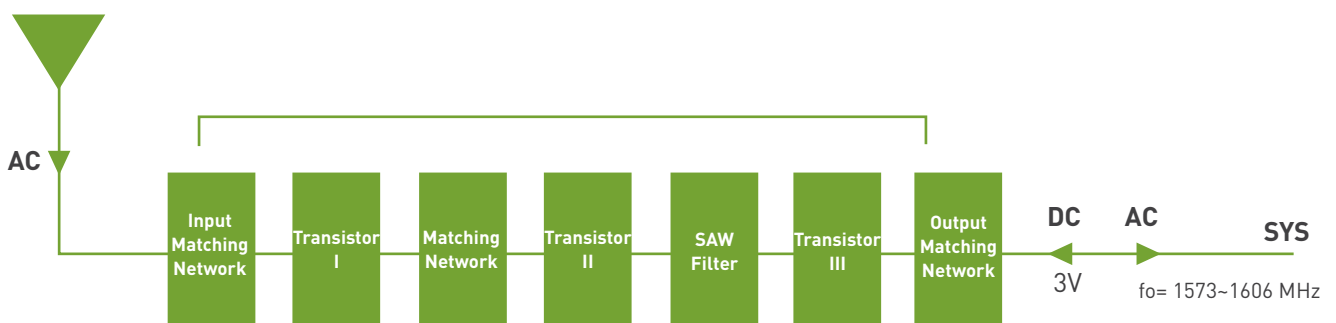
**Figure 24.** Radiation pattern at 1910 MHz, Figure 1 as reference (dB), with 2 meter RG174 cable and 60x60 cm metal plate

## 4.4 Radiation pattern



**Figure 25.** Radiation pattern at 2110 MHz, Figure 1 as reference (dB), with 2 meter RG174 cable and 60x60 cm metal plate

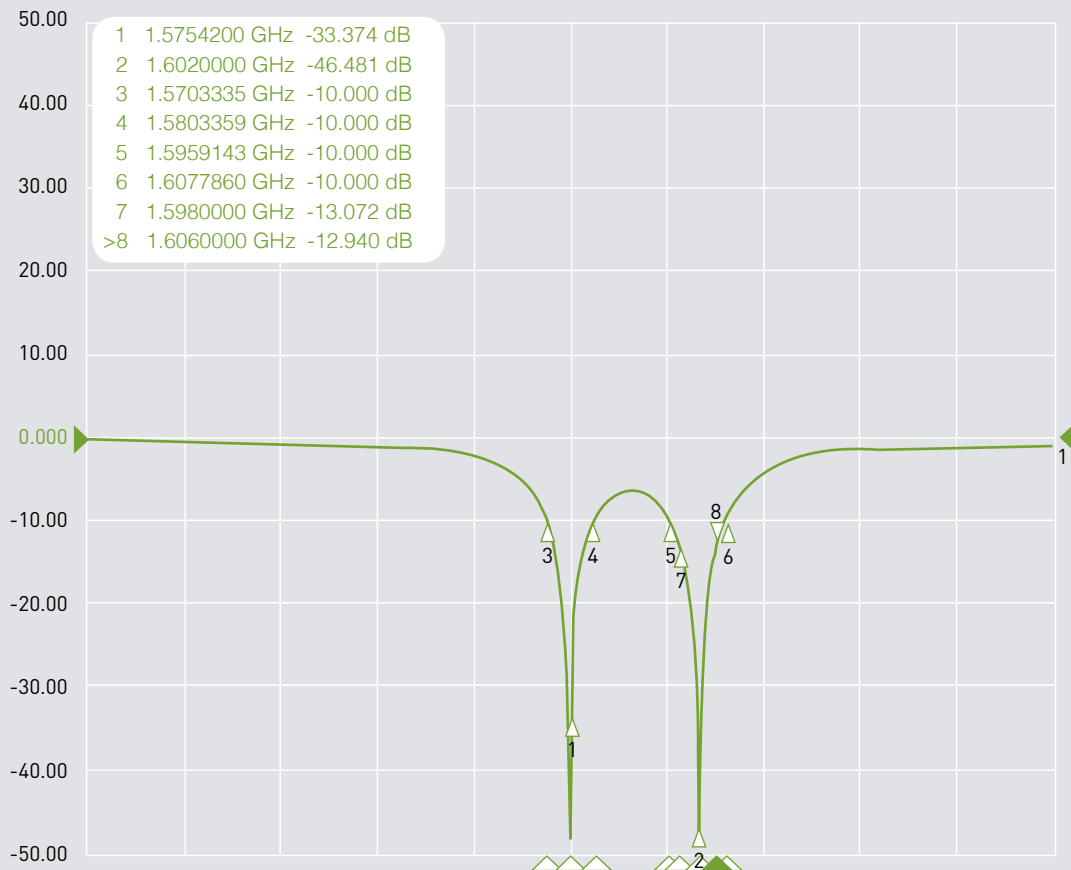
## 5. System Block Diagram



## 6. GPS-GLONASS Passive Antenna Results

### 6.1 Return Loss

▶ Tr1 S22 Log Mag 10.00dB/ Ref 0.000dB [F1 Del]



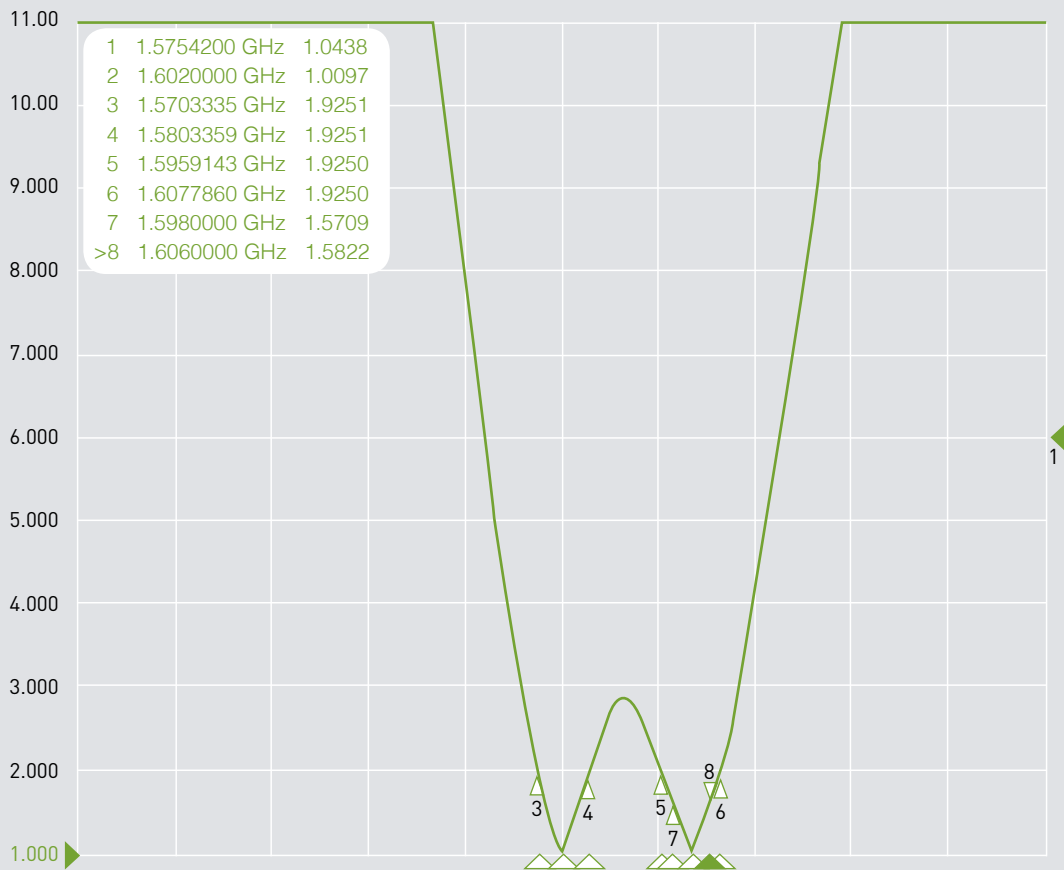
2 Center 1.57542 GHz

IFBW 70 kHz

Span 200 MHz

## 6.2 VSWR

Tr1 S22 SWR 1.000dB/ Ref 1.000 [F1 Del]



2 Center 1.57542 GHz

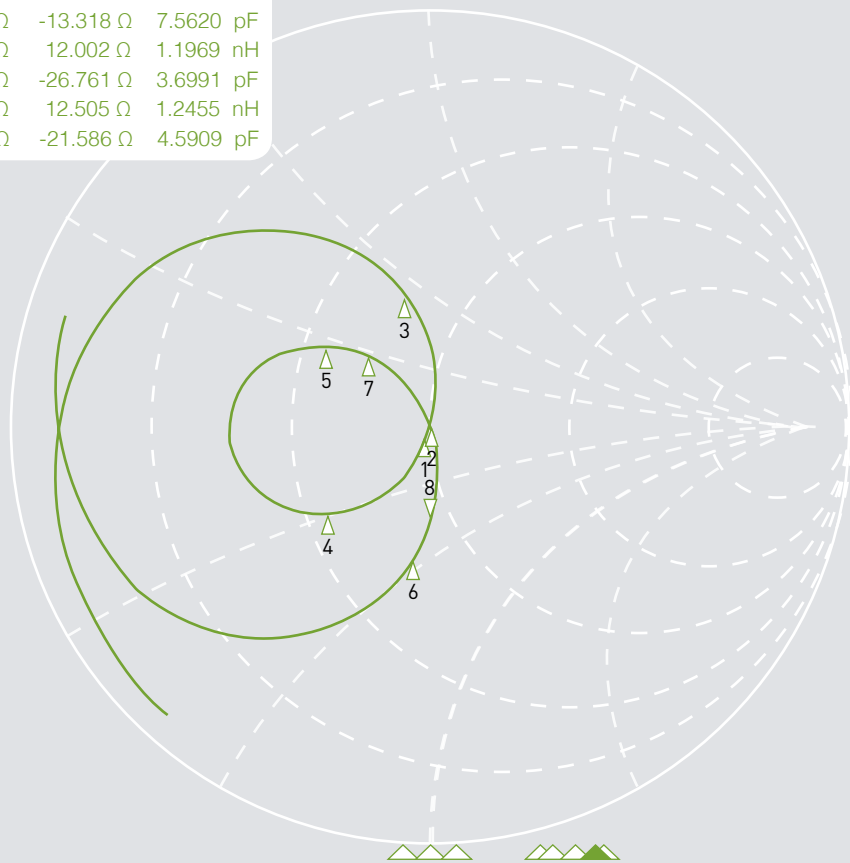
IFBW 70 kHz

Span 200 MHz

### 6.3 Smith Chart

▶ Tr1 S22 Smith (R + j) ( Scale 1.000U [F1 Del])

1	1.5754200 GHz	49.201 $\Omega$	-1.9717 $\Omega$	51.236 pF
2	1.6020000 GHz	50.311 $\Omega$	130.02 m $\Omega$	12.917 pH
3	1.5703335 GHz	36.885 $\Omega$	25.449 $\Omega$	2.5793 nH
4	1.5803359 GHz	28.597 $\Omega$	-13.318 $\Omega$	7.5620 pF
5	1.5959143 GHz	28.088 $\Omega$	12.002 $\Omega$	1.1969 nH
6	1.6077860 GHz	38.342 $\Omega$	-26.761 $\Omega$	3.6991 pF
7	1.5980000 GHz	35.460 $\Omega$	12.505 $\Omega$	1.2455 nH
>8	1.6060000 GHz	45.447 $\Omega$	-21.586 $\Omega$	4.5909 pF



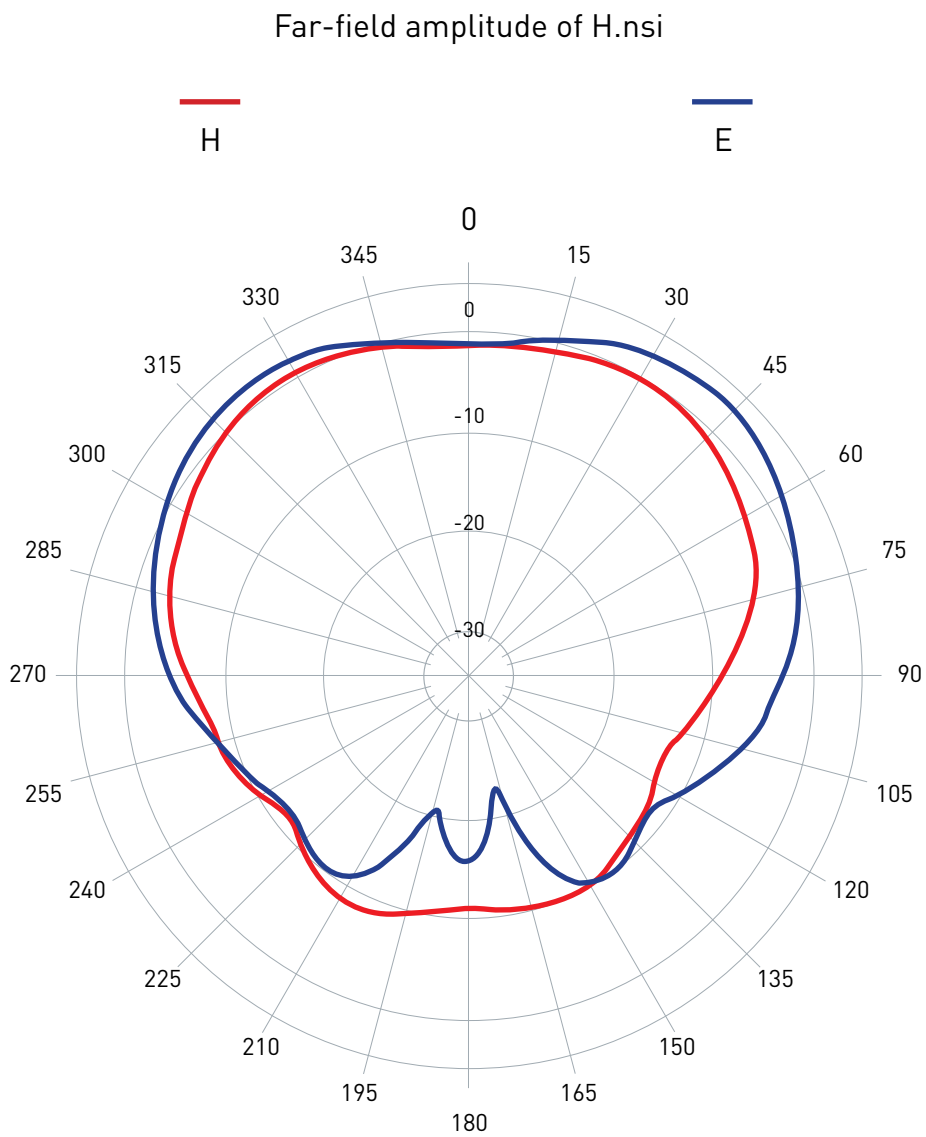
2 Center 1.57542 GHz

IFBW 70 kHz

SPAN 200 MHz

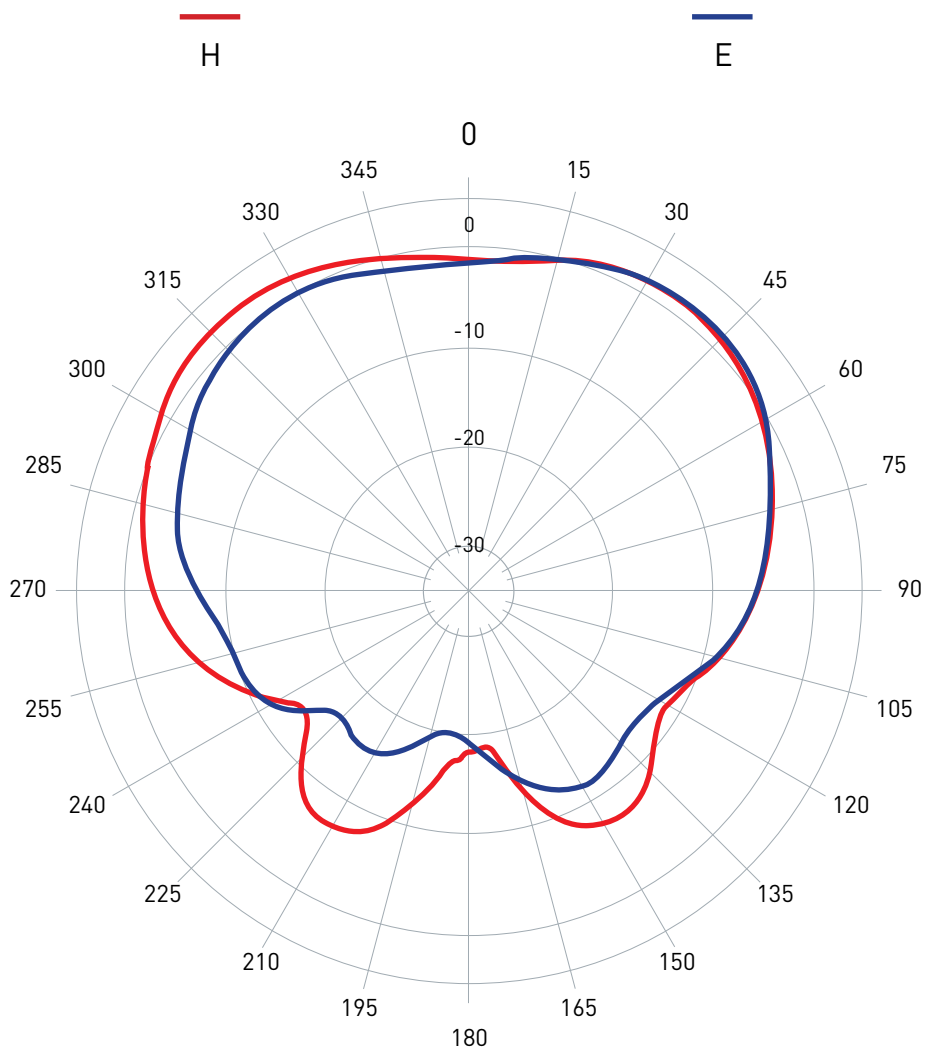
## 6.4 Radiation Patterns

### 6.4.1 1575.42MHz



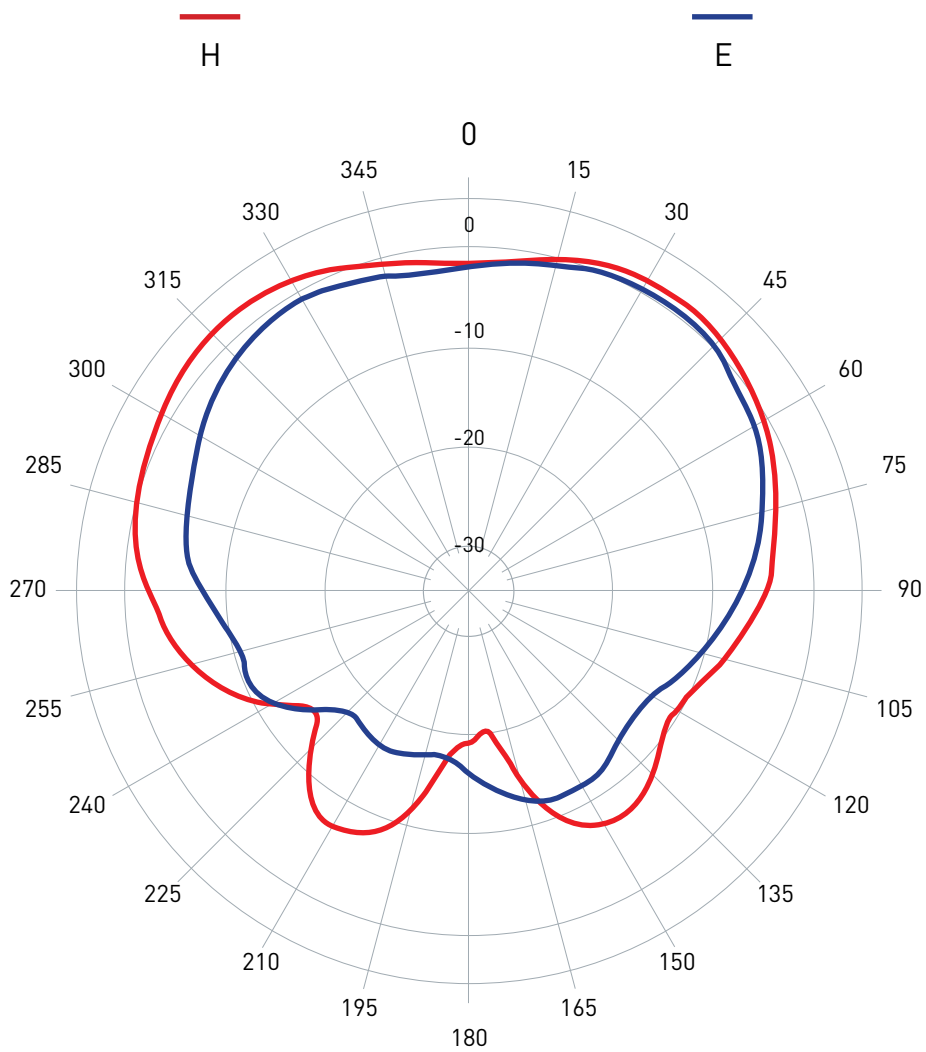
### 6.4.2 1598MHz

Far-field amplitude of H.nsi



### 6.4.3 1602MHz

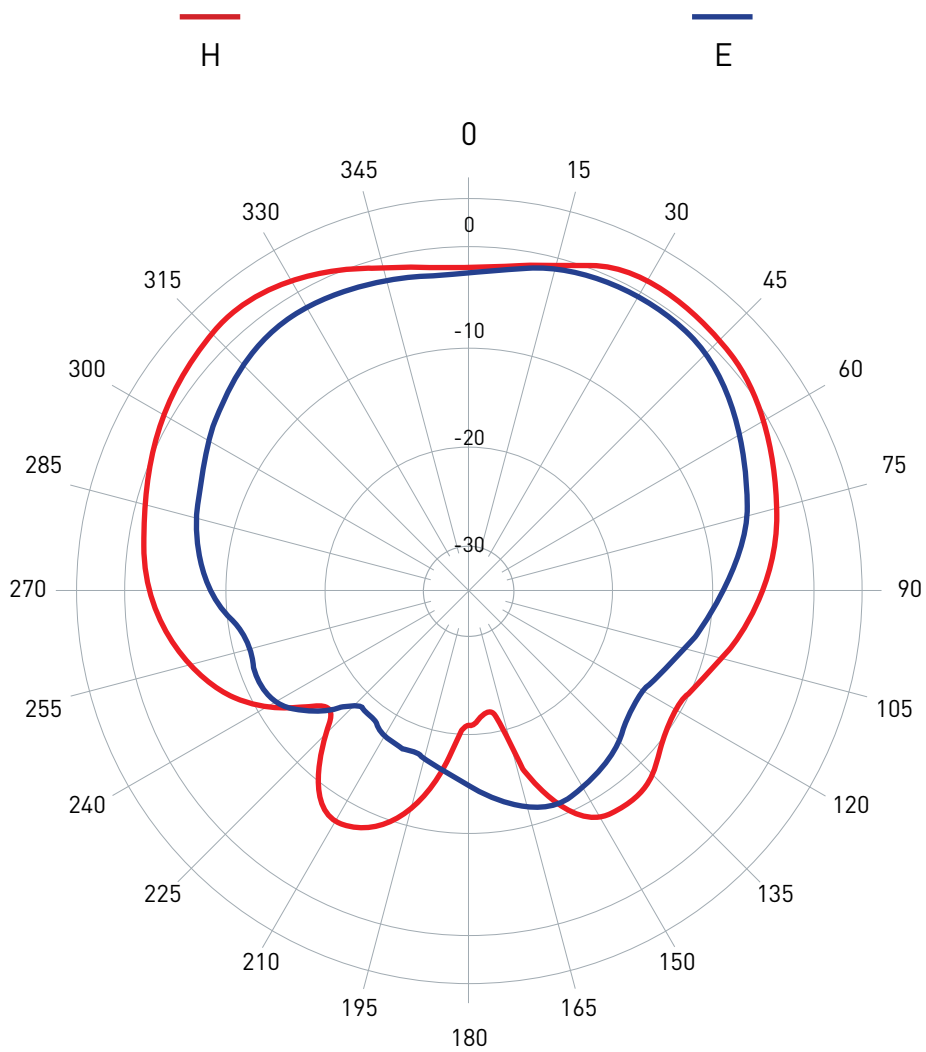
Far-field amplitude of H.nsi





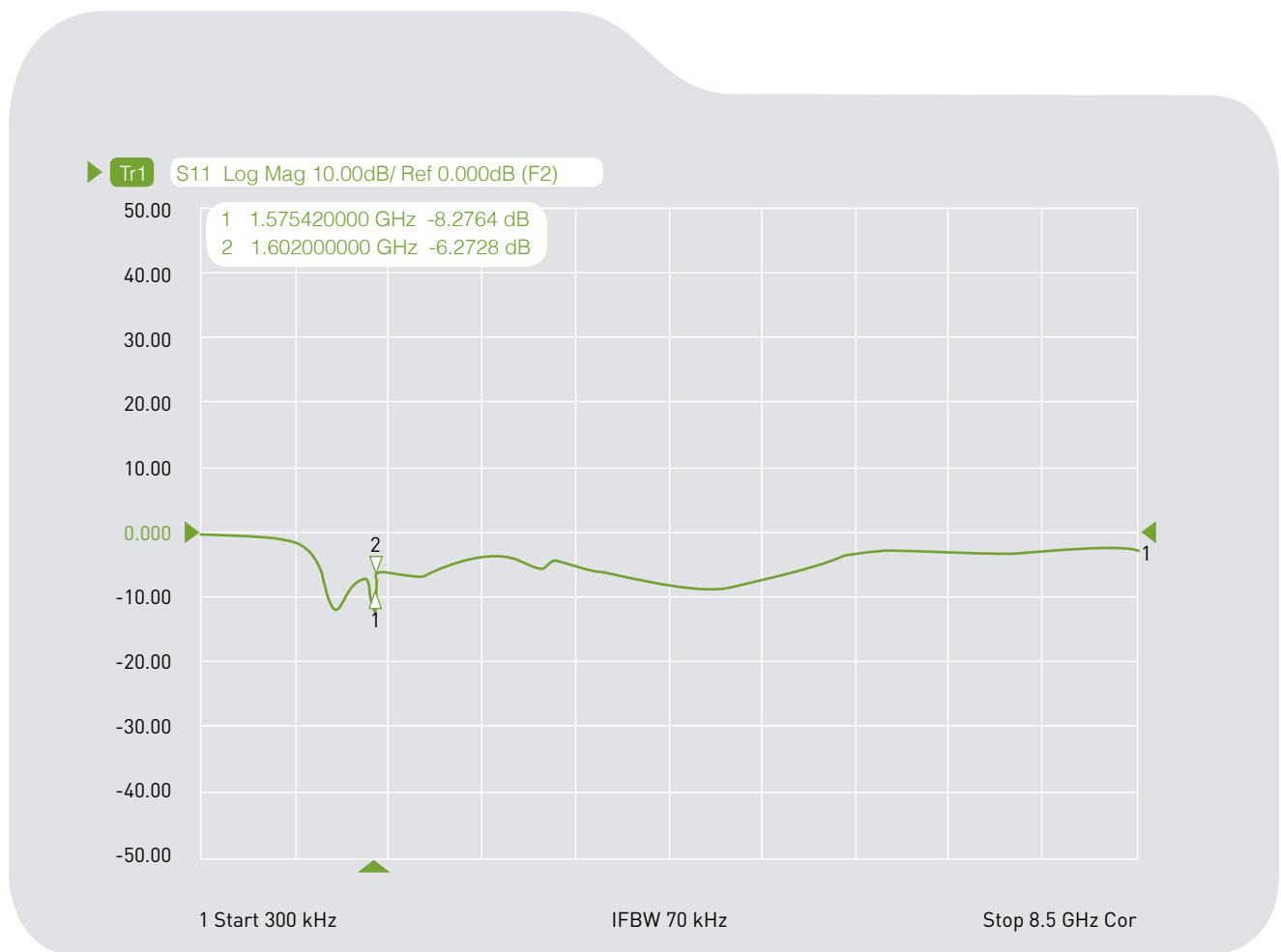
### 6.4.4 1602MHz

Far-field amplitude of H.nsi



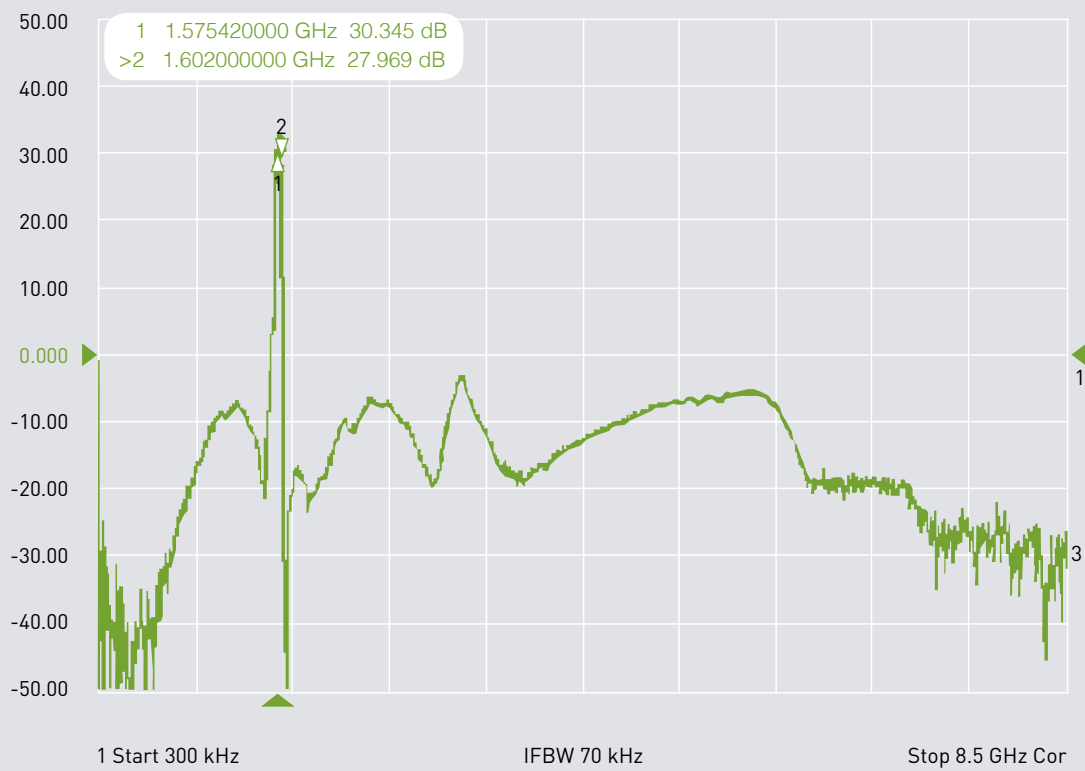
## 7. GPS - Low Noise Amplifier

### 7.1 S11 Return Loss

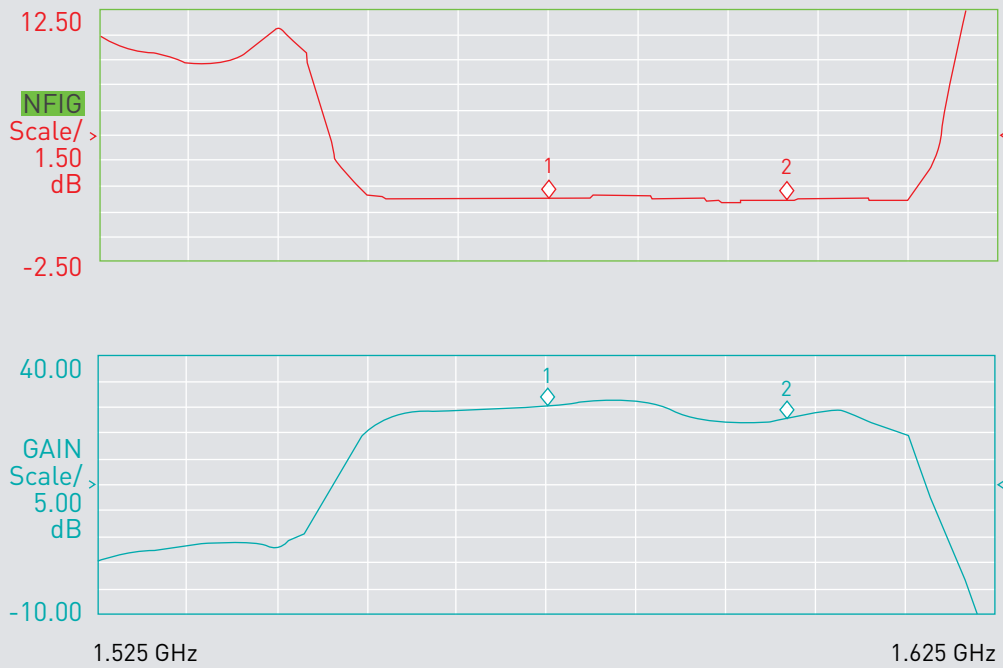


## 7.2 S21 Gain

▶ Tr3 S21 Log Mag 10.00dB/ Ref 0.000dB (F2)



### 7.3 Noise Figure

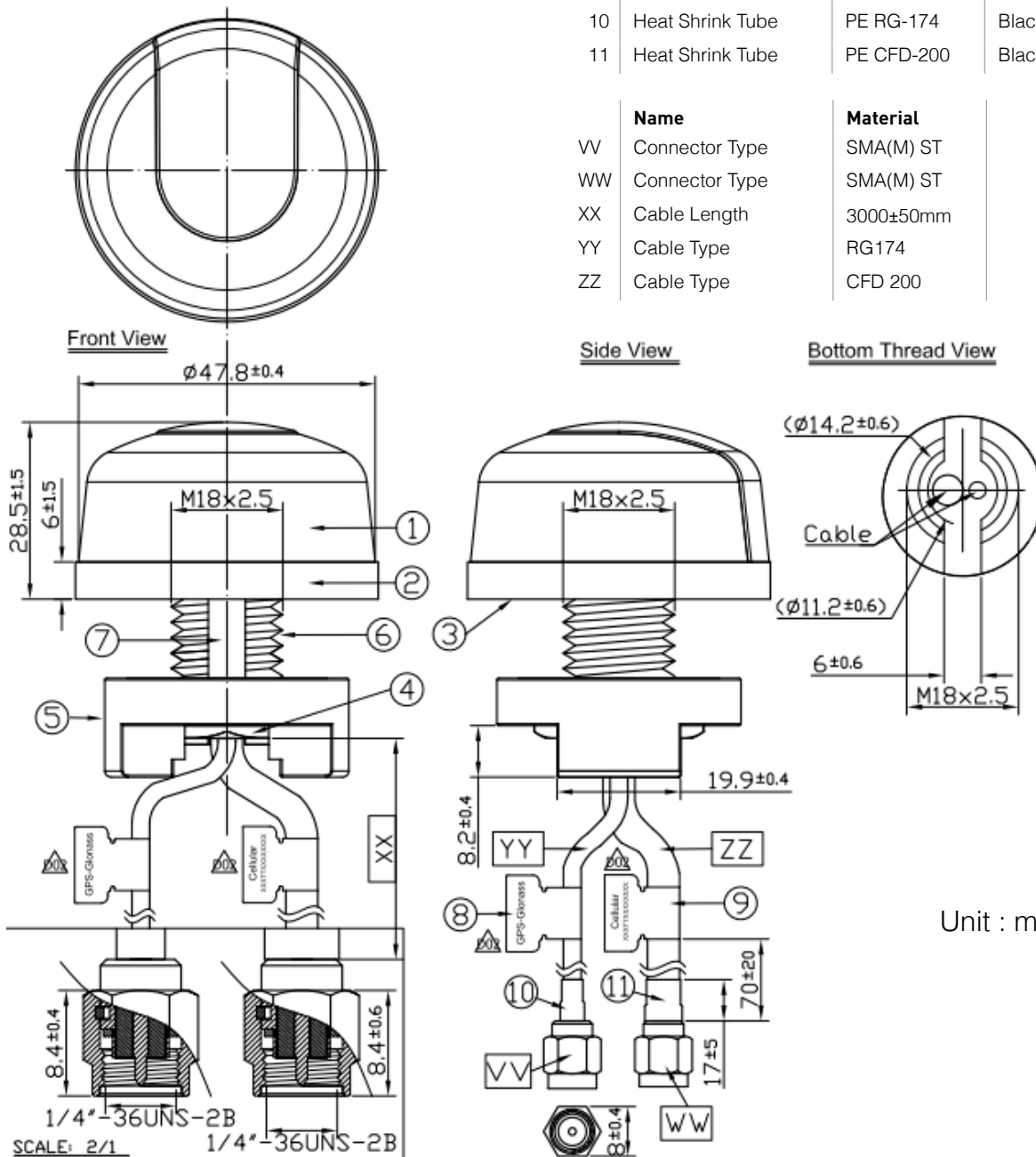


Markers			NFIG	GAIN
MKr1	1.5754 GHz		1.3977 dB	30.2930 dB
MKr2	1.6021 GHz		1.2314 dB	27.5857 dB

## 8. Drawing

	Name	Material	Finish	QTY
1	Housing	ABS	Black	1
2	Closed Cell Foam	CR 4305	Black	1
3	3M Double Adhesive	3M 9448 HK	White Liner	1
4	M18 Inner Nut	Carbon Steel	Ni Plated	1
5	Outer Nut Cover	ABS	Black	1
6	M18x2.5 Thread	Zinc Alloy	Ni Plated	1
7	Rubber Stopper	Rubber	Black	1
8	GPS-Glonass Label	Coated Paper	Orange	1
9	Cellular Label	Coated Paper	Blue	1
10	Heat Shrink Tube	PE RG-174	Black	1
11	Heat Shrink Tube	PE CFD-200	Black	1

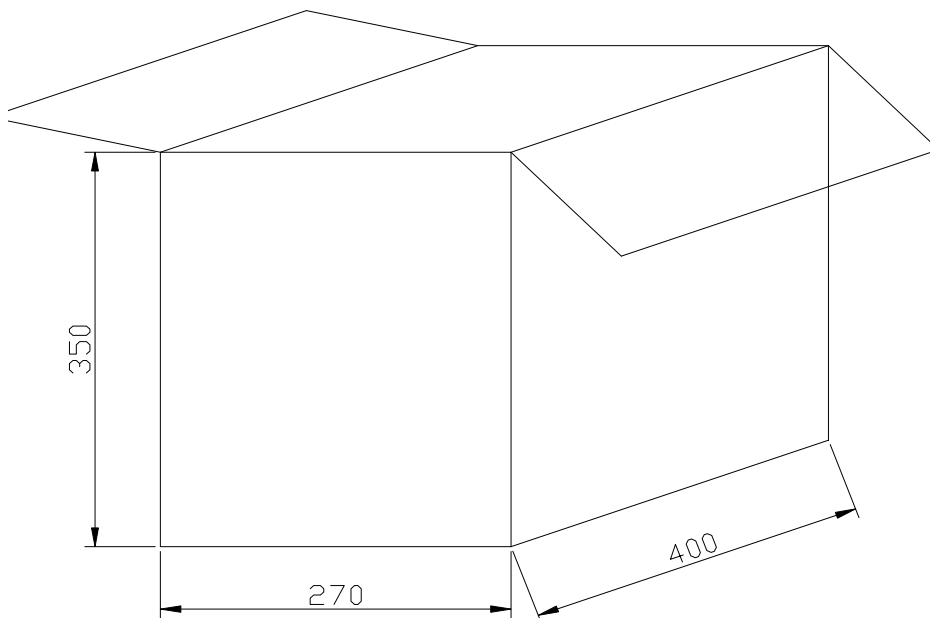
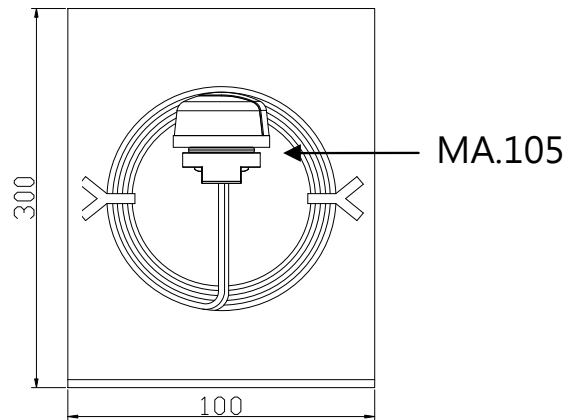
	Name	Material
VV	Connector Type	SMA(M) ST
WW	Connector Type	SMA(M) ST
XX	Cable Length	3000±50mm
YY	Cable Type	RG174
ZZ	Cable Type	CFD 200



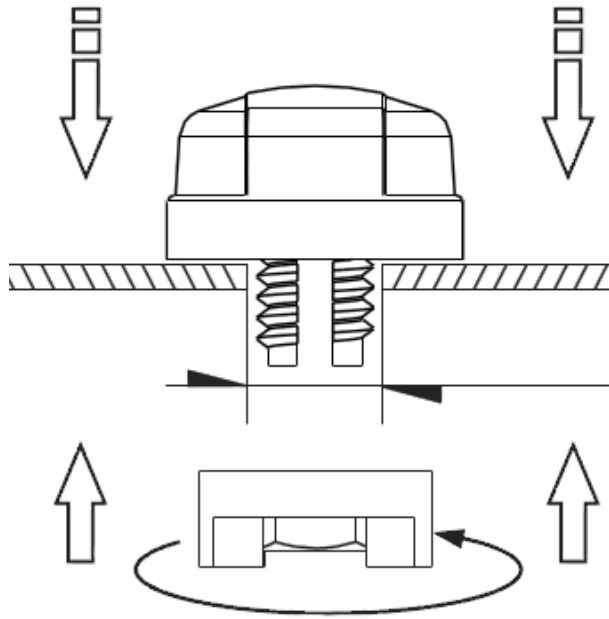
Unit : mm

## 9. Packaging

1 pc MA105 per large PE bag  
40 large PE bag per box  
Box Dimensions - 350\*270\*400



## 10. Installation



Recommended torque for mounting is 95N·m or 70ft lbs  
Maximum torque for mounting is 135.6N·m or 100ft lbs



Taoglas makes no warranties based on the accuracy or completeness of the contents of this document and reserves the right to make changes to specifications and product descriptions at any time without

notice. Taoglas reserves all rights to this document and the information contained herein.

Reproduction, use or disclosure to third parties without express permission is strictly prohibited.

Copyright © Taoglas Ltd.